

# Chug & Go Railroad™

## Track Configuration Instructions

Total track pieces: 34

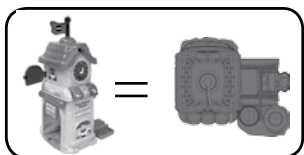

One electronic train station with one **SmartPoint®** track

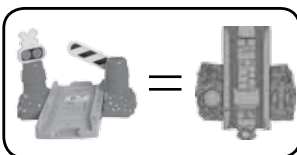

Two **SmartPoint®** straight tracks with traffic lights

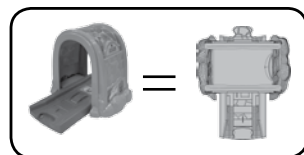

Two tunnels with **SmartPoint®** straight tracks

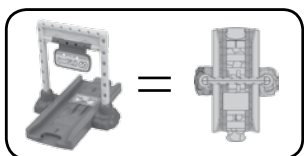

One **SmartPoint®** straight track with road sign

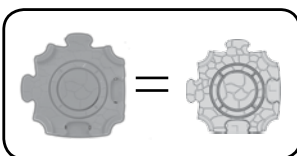

Three cross tracks

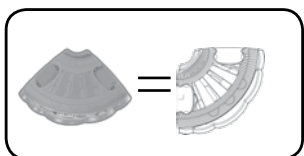

Seven 90-degree tracks, female

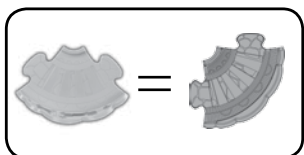

Seven 90-degree tracks, male

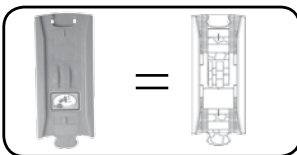

Two **SmartPoint®** straight tracks

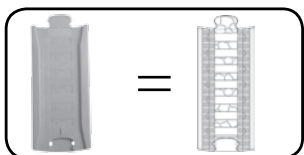

Two straight tracks

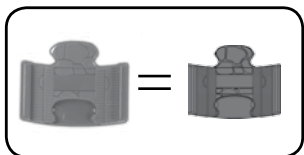

Seven 1/4 straight tracks



Two curved pieces for the cross tracks (change direction)

**Note:** Place the curved pieces for the cross tracks in the grooves on the cross tracks as needed. Use the curved pieces to guide the train down a desired path.

Figure 1

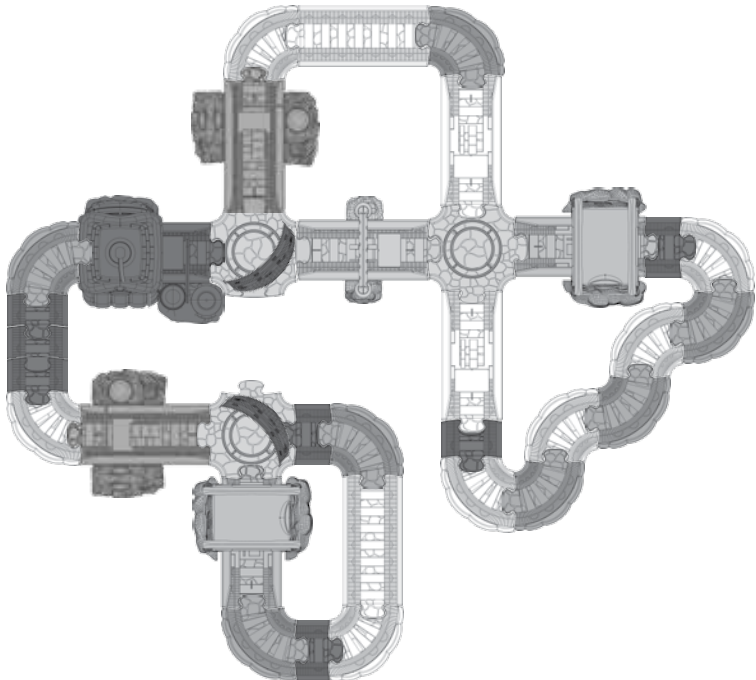
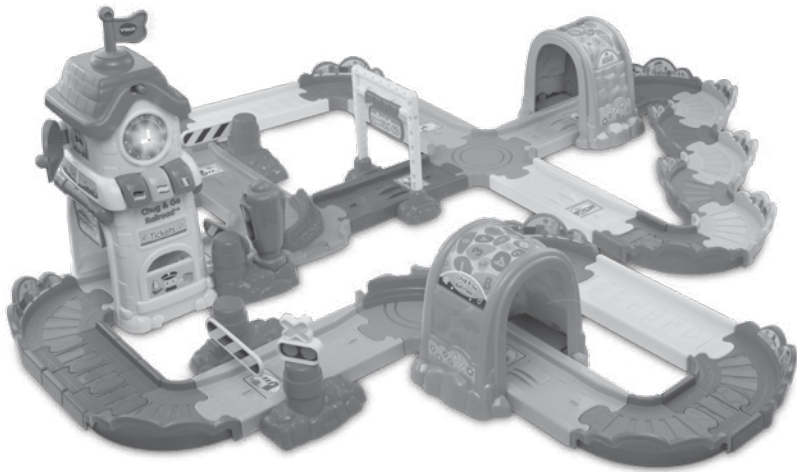

**Figure 2**

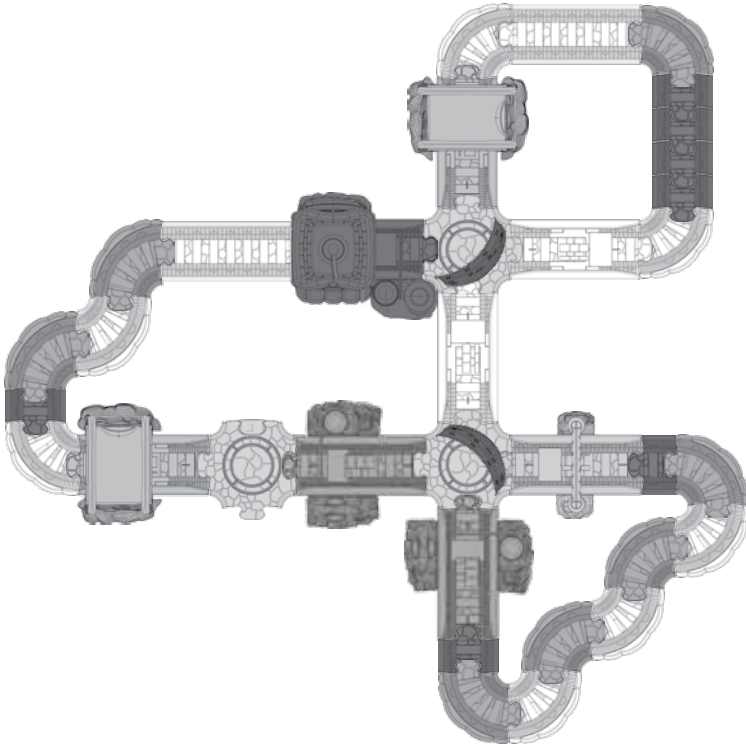
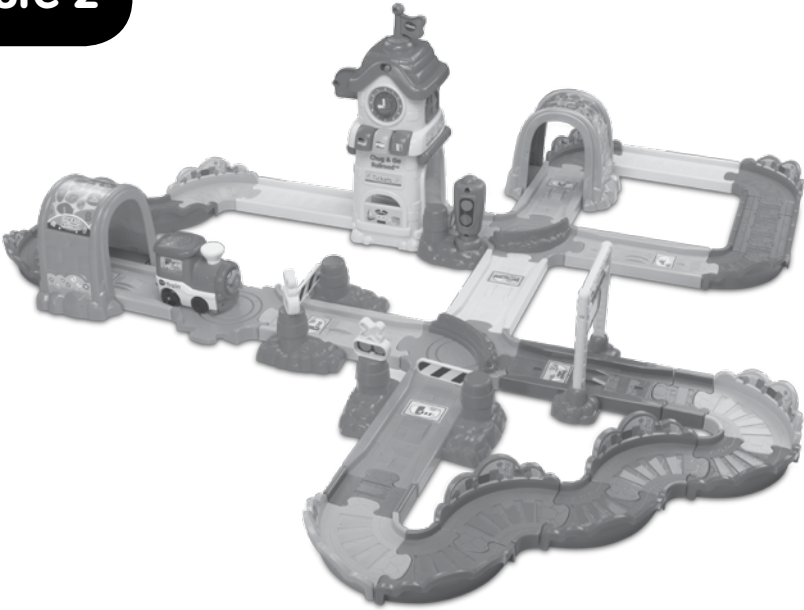

**Figure 3**

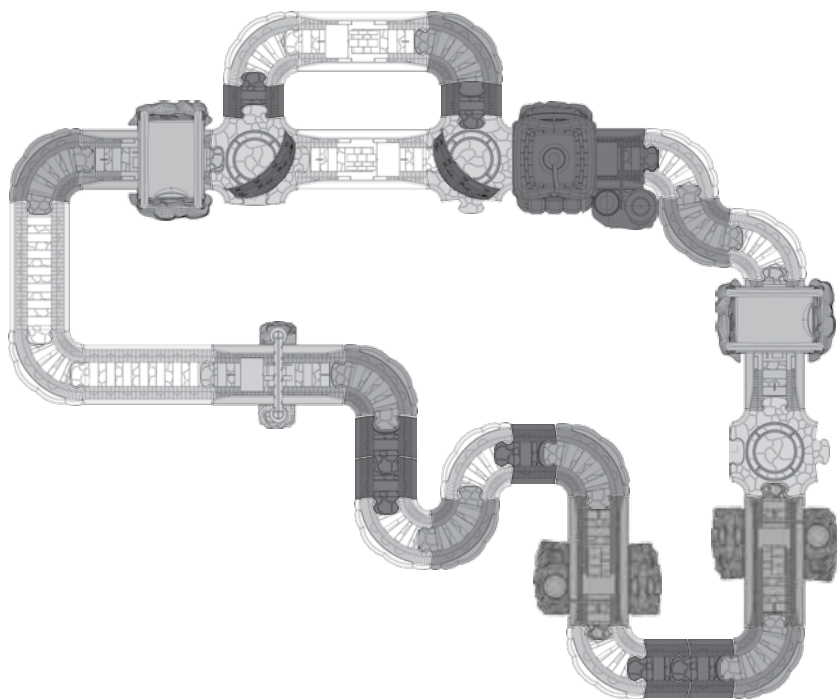
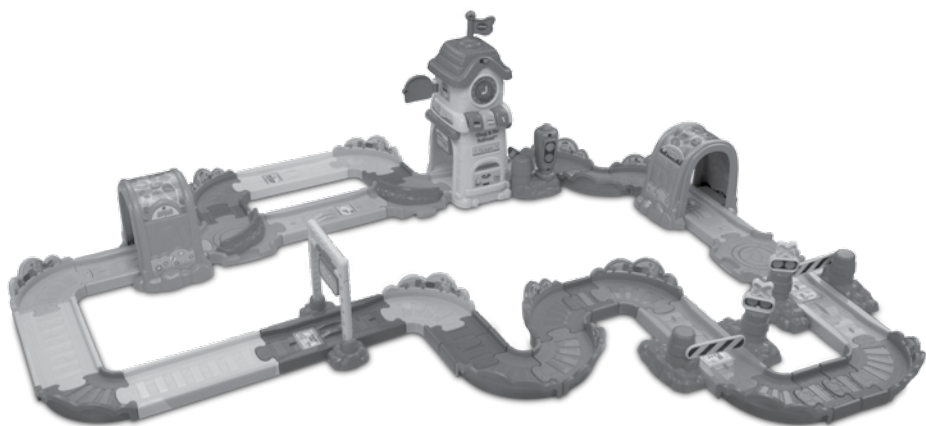

Figure 4

